



RADIO FREQUENCY SYSTEMS



RADIAFLEX® RADIATING CABLE SELECTION GUIDE

Edition 1 / 1.2023





DB

HAUPTBAHNHOF



Prince of India

RADIO FREQUENCY SYSTEMS

TABLE OF CONTENTS

RADIAFLEX® CABLES

An introduction to the world's most advanced
portfolio of 5G-ready radiating cables

[2](#)

PORTFOLIO OVERVIEW

A synopsis of RFS RADIAFLEX cable
types, applications, and frequencies

[4](#)

MIMO SOLUTIONS

Take advantage of new spectrum and
accelerate to 5G in tunnels

[5](#)

RADIAFLEX SPECIFICATIONS

Find RADIAFLEX cables for
every application and environment

[6](#)

CONNECTORS FOR RADIAFLEX CABLES

Premium performance connectors
support quick, easy and reliable installations

[10](#)

SAFETY IS KEY

CPR-compliant cables that are ideal for
indoor applications

[12](#)

STANDARDS AND REGULATIONS

Fire class categories and cable test standards
for RADIAFLEX and CELLFLEX cables

[14](#)

CELLFLEX® COAXIAL CABLES

In addition to RADIAFLEX, RFS offers
coaxial cables for in-building and in-tunnel

[15](#)

RADIAFLEX INSTALLATIONS

Everything you need to **install RADIAFLEX**
with confidence

[16](#)

RADIAFLEX OVERVIEW

Understanding the properties and design concepts
of our world-renowned radiating cables

[21](#)

THE WORLD'S MOST ADVANCED PORTFOLIO OF 5G-READY RADIATING CABLES

RADIAFLEX radiating cables take reliable, high-performance wireless coverage everywhere the cable is installed to eliminate the need for traditional antennas in confined indoor and underground spaces. These groundbreaking broadband cables changed the industry when we invented them in 1972, and they continue to set new benchmarks for speed, reliability and fire resistance today.

FUTUREPROOF YOUR CONNECTIVITY INVESTMENTS

Every RADIAFLEX radiating cable is 5G-ready, and can simultaneously deliver all commercial and mission-critical services up to 6 GHz with high performance.

You can support multiband, multi-operator applications in the most challenging indoor and underground environments today, and smoothly evolve to take advantage of new spectrum and deliver new services over time — with no need to replace cables.

FIND RADIAFLEX CABLES FOR EVERY APPLICATION AND ENVIRONMENT

With several different families of RADIAFLEX cables to choose from, you can find the right combination of bending radius, performance level and outer conductor type needed to support every application, in every environment. We offer RADIAFLEX cables that are optimized for:

- **5G applications** that require maximum throughput
- **Mission-critical applications** that require maximum reliability
- **High-frequency and digital applications** that require extremely low losses
- **Mining and industrial applications** that require maximum durability with no compromises to cable flexibility
- **In-vehicle applications** that require maximum cable flexibility
- **Long cable runs** with sustained high performance

We can also customize RADIAFLEX cables for your specific applications, environment and goals.

Used in more than
50%
of the world's
metros and tunnels.

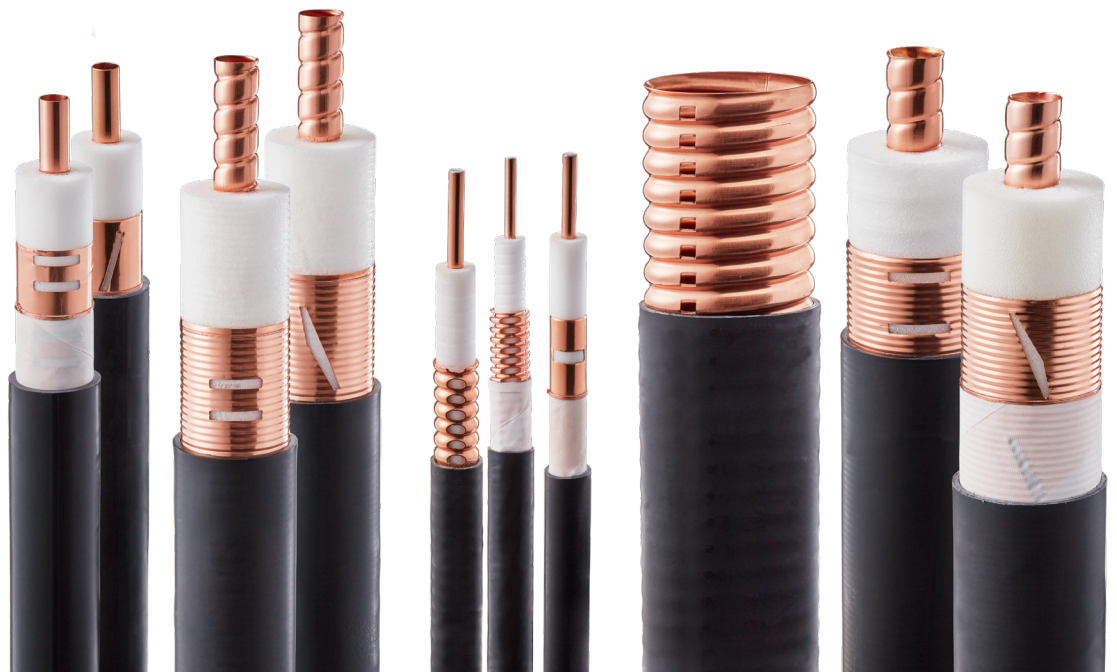

THE WORLD'S MOST ADVANCED PORTFOLIO OF 5G-READY RADIATING CABLES

INCREASE FIRE SAFETY TO PROTECT LIVES

RADIAFLEX cables are tested and proven to minimize flame spread and smoke emissions. You'll find RADIAFLEX cables that comply with:

- All major International Electromechanical Commission (IEC) standards for low smoke, flame and fire retardance:
 - IEC 60754-1/-2: Halogen-free and non-corrosive jacket tests
 - IEC 60332-1: Flame tests
 - IEC 60332-3-24: Cable bundle tests
 - IEC 61034: Low-smoke emission tests
- The highest Construction Products Regulation (CPR) standards for burning droplets (d0), low smoke emission (s1) and corrosivity (a1)
- The National Fire Protection Association (NFPA) 130 standard for Fixed Guideway Transit and Passenger Rail Systems

SIMPLIFY END-TO-END DAS DEPLOYMENTS

To complement our RADIAFLEX radiating cables, we offer a complete family of installation tools, accessories, and coaxial cable solutions including:

- **RADIAFLEX cable connectors** that minimize passive intermodulation (PIM) to ensure interference doesn't affect quality of service or performance
- **Radiating waveguides** that simultaneously support multiple one-way and two-way communications systems so a single waveguide can be used for all applications
- **Robust clamps and smart fixing solutions** with fire-protection inserts for all installation scenarios
- **CELLFLEX® high-performance, flame-retardant coaxial cables, jumpers and OMNI FIT™ connectors** for every distributed antenna (DAS) deployment

CHOOSE THE WORLD'S MOST TRUSTED RADIATING CABLES

RADIAFLEX radiating cables are delivering reliable, high-performance wireless connectivity in more than 50% of the world's metros and in iconic tunnels around the world, including:

- Grand Paris Express rapid transit lines
- Follobanen high-speed railway
- Metro Rio De Janeiro
- New York Metro
- Singapore Metro
- Hong Kong metro
- London Crossrail railway
- Eurotunnel
- Fréjus road tunnel
- CERN Super Proton Synchrotron (SPS)

RELY ON OUR WORLD-RENOWNED EXPERTISE

As the world's leading experts in radiating cable technologies, we've provided technical insight, guidance and fully customized solutions for some of the most unique and challenging wireless connectivity deployments globally. We can help you:

- Deliver reliable, uninterrupted wireless connectivity in hostile, ultra-confined underground environments with poor ventilation
- Ensure optimal radio signal propagation in areas where tunnel curves and signal blockages due to passing trains significantly increase complexity
- Maintain signal strength and quality inside fast-moving trains packed with passengers while compensating for losses caused by train materials and human bodies

Learn about our latest successes: <https://bit.ly/3V4D7ep>



PORTFOLIO OVERVIEW

RADIAFLEX RADIATING CABLES

	5G Commercial Radio									
	Mission Critical	4G Commercial Radio								
	75-450 MHz	600-960 MHz	617-960 MHz	1700-1900 MHz	2200 MHz	2700 MHz	3800 MHz	4200 MHz	4900 MHz	6000 MHz
5G RADIAFLEX Radiating Cable Solution										
RLKX114-50*	+	++	++	++	++	+++	+++			
RLKX114-50B	+	++	++	++	++	+++	+++	+++		
RAYX114-50*	+	++	++	++	++	+++	+++			
RLKAX12-50	+	+	+	+	++	++	++	++	++	++
RE60										+++
4G RADIAFLEX Radiating Cables										
RLKU158-50*	+	++	++	+++	+++	+++				
RAYA158-50*	+	++	++	+++	+++	+++				
RLKU114-50*	+	++	++	+++	+++	+++				
RAYA114-50*	++	++	++	+++	+++	+++				
RLKU78-50	+	++	++	+++	+++	+++				
RLKU12-50	+	++	++	+++	+++	+++				
Mission Critical Radio Application										
RLK158-50	+++	++	++							
RLK114-50	+++	++	++							
RLK78-50	+++	++	++							
RLK12-50	+++	++	++							
RLKW114-50	++	+++	+++	++						
RLKW78-50	++	+++	+++	++						
RLKW12-50	++	+++	+++	++						
GSM-R Applications										
RAY158-50	++	+++	+++							
RAY114-50	++	+++	+++							
RAY78-50	++	+++	+++							
Diverse Applications										
RCF12-50	+	+	+	+	+	+	+	+	+	+
RSF12-50	+	+	+	+	+	+	+	+	+	+
RCF78-50	+	+	+	+	+	+	+			
RLFU158	++	++	++	++	++					
RLFU114	++	++	++	++	++					
RLFU78	++	++	++	++	++					

* MIMO cables

ACCELERATE TO 5G IN TUNNELS WITH THE WORLD'S FASTEST MIMO SOLUTIONS

In 2018, we set a world record for in-tunnel download speeds with a dual-cable MIMO solution that reached 560 Mb/s. We did it by combining two perfect-match RADIAFLEX cables: one with horizontal polarization and one with vertical polarization.

Today, we offer the world's first pair of ultra-broadband radiating cables for cross-polarized MIMO applications to help you achieve the fastest possible MIMO speeds. When these patented RADIAFLEX cables are combined, the cross-polarizations effects optimize channel decorrelation conditions to maximize throughput efficiency in 2x2, 4x4 and higher MIMO applications.

TAKE ADVANTAGE OF NEW SPECTRUM

Our unique mode suppression technology means RADIAFLEX are the only radiating cables on the market that can operate in all 3GPP standardized frequency bands up to 4.2 GHz with no stopbands. As a result, they're ideal to take advantage of 3.5 GHz spectrum and deliver the next generations of commercial and mission-critical services. They also simplify spectrum rebanding and refarming projects so you can flexibly adapt your operations to support new applications and services as needed.

SEE THE TEST RESULTS FOR YOURSELF

Our direct comparison of single- and dual-cable MIMO test cases confirms a dual-cable, dual-polarized MIMO configuration outperforms a single-cable configuration and a dual-cable configuration where both cables have the same polarization.

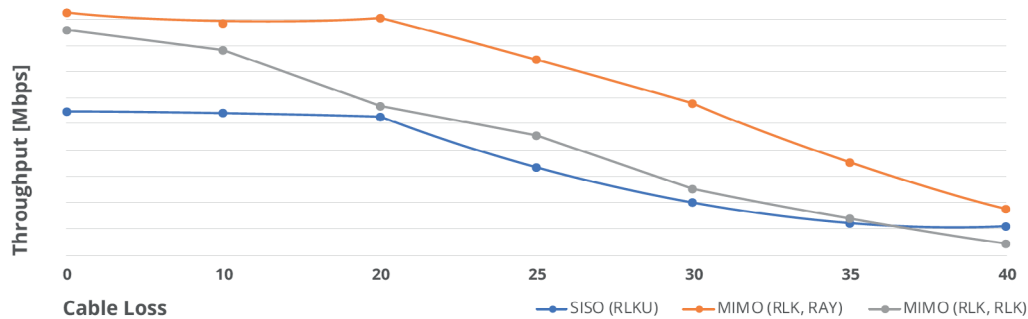

BUILD YOUR DUAL-CABLE RADIAFLEX SOLUTION



To optimize MIMO conditions in your environment, combine one cable from our vertically polarized RAY cable family and one from our horizontally polarized RLK cable family:

- 4G: RAYA158 and RLKU158
- 5G: RAYX114 and RLKX114





5G RADIAFLEX RADIATING CABLES



MODEL NAME	RLKX114	RAYX114	COMING SOON
Product Profile			
Maximum Operating frequency	3800MHz		
Dominant Polarization in dedicated bands of operation	Horizontal	Vertical	
Application	Commercial and mission critical radio applications in all kind of metro, rail and street tunnels		
Characteristics and Features	<p>An Unbeatable Feature Set Optimized for Performance</p> <p>Unique Radiating Cable Design The only cable available with no stop bands across the full spectrum</p> <p>Ultra-broadband RF Bandwidth Simultaneously supports all 2G, 3G, 4G and 5G commercial wireless bands and all mission-critical bands</p> <p>A solution for any MIMO Application Supports all single, dual, and multiple MIMO design approaches</p> <p>Ready for the Future Supports additional wireless services up to 3800 MHz, or allows for spectrum re-banding/re-farming</p>		

MODEL NAME	RLKAX12	RE60
Product Profile		
Maximum Operating frequency	7200MHz	5000-6000MHz
Dominant Polarization in dedicated bands of operation	Horizontal	Vertical
Application	all tunnel and indoor environments	
Characteristics and Features	<ul style="list-style-type: none"> • Ultra-broadband applications in wireless local-area networks (WLANs) and 5G frequency bands • Support of all 802.11 standards including latest 802.11ax 	<ul style="list-style-type: none"> • Optimized RF conditions allow for lowest overall TCO in the 6000MHz spectrum • Best system performance ensures longest amplifier spacings and related ecological aspects such as CO2 savings • Lowest system loss performance: the RE60 has a comparable system loss at 6 GHz than radiating cables operating in the 2.4 GHz ISM band

4G RADIAFLEX RADIATING CABLES

MODEL NAME	RLKU158 RLKU114 RLKU78 RLKU12	RAYA158 RAYA114
Product Profile		
Maximum Operating frequency	2700MHz	
Dominant Polarization in dedicated bands of operation	Horizontal	Vertical
Application	All types of metro, rail and street tunnels	
Characteristics and Features	<p>An Unbeatable Feature Set Optimized for Performance</p> <p>Unique Radiating Cable Design The only cable available with no stop bands across the full spectrum</p> <p>Ultra-broadband RF Bandwidth Simultaneously supports all 2G, 3G, 4G and 5G commercial wireless bands and all mission-critical bands</p> <p>A solution for any MIMO Application Supports all single, dual, and multiple MIMO design approaches</p> <p>Ready for the Future Ensures the most futureproof confined coverage installation</p>	

MISSION CRITICAL RADIO APPLICATIONS

MODEL NAME	RLK158 RLK114 RLK78 RLK12	RLKW158 RLKW114 RLKW78 RLKW12
Product Profile		
Maximum Operating frequency	980MHz	1950MHz
Dominant Polarization in dedicated bands of operation	Horizontal	
Application	All types of metro, rail and street tunnels; in-building applications	
Characteristics and Features	<ul style="list-style-type: none"> • Optimized for Performance • The only cable available with no stop bands across the full spectrum • Simultaneously supports all 2G, 3G, 4G and 5G 	

GSM-R APPLICATIONS

MODEL NAME	RAY158 RAY114 RAY78
Product Profile	
Maximum Operating frequency	1000MHz
Dominant Polarization in dedicated bands of operation	Vertical
Application	GSM-R type applications
Characteristics and Features	<ul style="list-style-type: none"> • Dominant vertical polarization makes this cable ideal for operation on vertically polarized train antennas • Combined VHF, TETRA and GSM-R systems



DIVERSE APPLICATIONS

MODEL NAME	RCF12	RCF78	RSF12
Product Profile			
Maximum Operating frequency	6000MHZ	3800MHz	6000MHz
Dominant Polarization in dedicated bands of operation	Homogenous		
Application	Installation on various confined areas with challenging installation constraints		
Characteristics and Features	<ul style="list-style-type: none"> • MSHA approved cable for mining industry • Improved mechanical properties to ensure installation under challenging environmental conditions • Ideally suited for applications that require low bending radii 		<ul style="list-style-type: none"> • Ultra-flexible design of the cable make it ideally suited for in-train installation and in-vehicle installation as well as in-building • Ideally suited for applications that require low bending radii

MODEL NAME	RLFU158 RLFU114 RLFU78
Product Profile	
Maximum Operating frequency	2400MHz
Dominant Polarization in dedicated bands of operation	Homogenous
Application	Heavy-duty wideband radiating cable for multi-use applications in tunnels of all kinds
Characteristics and Features	<ul style="list-style-type: none"> • Withstands hostile environmental conditions such as dirty or dusty tunnels

CONNECTORS FOR RADIAFLEX RADIATING CABLES

Premium Performance
Radiating Cable Connectors
Support Quick, Easy and
Reliable Installation

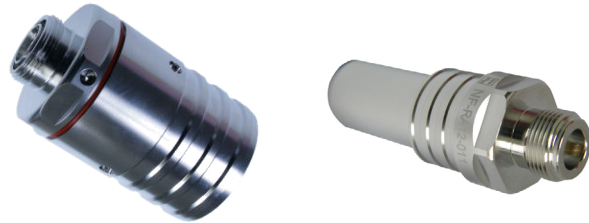

PIM-RATED FOR THE HIGHEST QUALITY CONNECTOR-CABLE INTERFACE

RFS' PIM-rated radiating cable connectors are designed specifically to provide the highest quality connector-cable interface while simplifying and speeding up the attachment of connectors to RFS radiating cables. Connectors are available in 7-16 DIN interfaces (additional models for type N interfaces coming soon). The robust two-piece mechanical design enables a stable connection with the cable for best-in-class PIM performance. The connectors consist of both a back nut and body for secure positioning, and then are pre-assembled before delivery and easily attach to the prepared cable in one piece. This assures error-free attachment and avoids unnecessary connector adjustments, while allowing for reuse and repositioning in the future as needed.

RFS connectors are completely waterproof to assure safe, long-term operation in the harshest of environments. All connectors are fully tested for mechanical and electrical and compliance specifications and provide low VSWR for excellent electrical performance.

- **Fast and easy installation** — eliminates unnecessary connector adjustments and provides outstanding performance
- **Robust mechanical design** — Provides best-in-class PIM performance
- **Low VSWR** — Ensures excellent electrical performance
- **Totally waterproof** — provides safe, long-term operation in the harshest of environments

CONNECTOR INSTRUCTIONS



Access Installation Sheets and Videos

Fast and easy access to installation instructions:

- Printed instructions available in every connector box
- On the go – access the installation docs from a link on the datasheets

Watch our videos to learn the installation process:

- Step-by step-visuals and techniques to ensure best practices
- Videos are led by our field engineers and tech support team

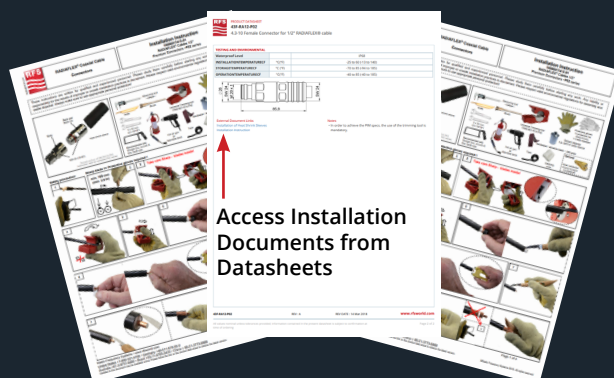

CONNECTORS FOR RADIAFLEX RADIATING CABLES

CABLE TYPE (* = JACKET OPTION)	STANDARD CONNECTOR	INSTALLATION PREPARATION TOOL	PREMIUM CONNECTOR	INSTALLATION PREPARATION TOOL
-----------------------------------	-----------------------	----------------------------------	----------------------	----------------------------------

1/2" Cable Size (Diameter)

RFS12-50*	43M-SCF12-C03	TRIM-SET-S12-C02	43M-SCF12-E01* ²	TRIM-SET-S12-D01
	43F-SCF12-C03	TRIM-SET-S12-C02	43F-SCF12-E01* ²	TRIM-SET-S12-D01
	NF-SCF12-C03	TRIM-SET-S12-C02	NF-SCF12-E01* ²	TRIM-SET-S12-D01
	NM-SCF12-C03	TRIM-SET-S12-C02	NM-SCF12-E01* ²	TRIM-SET-S12-D01
	716F-SCF12-C03	TRIM-SET-S12-C02	716F-SCF12-E01* ²	TRIM-SET-S12-D01
	716M-SCF12-C03	TRIM-SET-S12-C02	716M-SCF12-E01* ²	TRIM-SET-S12-D01
RCF12-50*	43M-LCF12-C03* ²	TRIM-SET-L12-C02	43M-SCF12-E01* ²	TRIM-SET-L12-D01
	43F-LCF12-C03* ²	TRIM-SET-L12-C02	43F-SCF12-E01* ²	TRIM-SET-L12-D01
	NM-LCF12-C03* ²	TRIM-SET-L12-C02	NF-SCF12-E01* ²	TRIM-SET-L12-D01
	716M-LCF12-C03* ²	TRIM-SET-L12-C02	716F-SCF12-E01* ²	TRIM-SET-L12-D01
RLK12-50* RLKW12-50* RLKU12-50*	NF-RA12-012	not required	43F-RA12-P02* ³	TRIM-SET-R12-P02
	NM-RA12-011	not required	NF-RA12-P02* ³	TRIM-SET-R12-P02
	N/A	N/A	NM-RA12-P02* ³	TRIM-SET-R12-P02

7/8" Cable Size (Diameter)

RCF78-50*	43M-LCF78-C03* ³	TRIM-SET-L78-C02	43M-LCF78-E01* ³	TRIM-SET-L78-E01
	43F-LCF78-C03* ³	TRIM-SET-L78-C02	43F-LCF78-E01* ³	TRIM-SET-L78-E01
	NF-LCF78-C03* ³	TRIM-SET-L78-C02	NF-LCF78-E01* ³	TRIM-SET-L78-E01
	NM-LCF78-C03* ³	TRIM-SET-L78-C02	NM-LCF78-E01* ³	TRIM-SET-L78-E01
	716F-LCF78-C03* ³	TRIM-SET-L78-C02	716F-LCF78-E01* ³	TRIM-SET-L78-E01
	716M-LCF78-C03* ³	TRIM-SET-L78-C02	716M-LCF78-E01* ³	TRIM-SET-L78-E01
RLK78-50* RLKW78-50* RLKU78-50*	NF-RA78-016	not required	43F-RA78-P02* ³	TRIM-SET-R78-P02
	NM-RA78-015	not required	716F-RA78-P02* ³	TRIM-SET-R78-P02
	716F-RA78-016	not required	716M-RA78-P03* ³	TRIM-SET-R78-P02
	716M-RA78-015	not required		

1-1/4" Cable Size (Diameter)

RLF114-50* RLFU114-50* RLK114-50* RLKW114-50* RLKX114-50*	NF-RA114-016	not required	43F-RA114-P02	TRIM-SET-R114-P02
	716F-RA114-016	not required	716F-RA114-P02	TRIM-SET-R114-P02

1-5/8" Cable Size (Diameter)

RLF158-50* RLFU158-50* RLK158-50* RLKW158-50* RLKU158-50* RAY158-50* RAYA158-50*	NF-RA158-016	not required	43F-RA158-P02	TRIM-SET-R158-P02
	716F-RA18-016	not required	716F-RA158-P02	TRIM-SET-R158-P02

Heat Shrink Sleeves

USE FOR:	MODEL NUMBER
RFS 12-50* cable connectors	HEAT-328-012
RCF 12-50* cable connectors	HEAT-328-018
RCF 78-50* cable connectors	HEAT-3812-014
RCF 114-50* cable connectors	HEAT-5016-024
RCF 158-50* cable connectors	HEAT-6319-026

ORDERING INFORMATION

- * Cable jacket option, e.g. JFN, JFL, CPR
- *² An additional heat shrink sleeve is required and must be ordered
- *³ In order to achieve the PIM specification, the use of the noted trimming tool is required.





ROBUST JACKET CONSTRUCTION ENABLES THE HIGHEST CPR CLASSIFICATIONS

RFS CPR-compliant coax and radiating cables feature a specially developed jacket that allows them to achieve best-in-class ratings for burning droplets (d0), low smoke emission (s1) and corrosivity (a1), the most important criteria for fire safety in cables that are installed indoors and underground.









All RFS cables are tested and certified by an external notified body according to EN 50575. In addition, RFS' manufacturing facility in Hannover, Germany, has been audited and meets the highest system 1+ requirements for type approvals, regular production audits, as well as regular sampling and testing of products by the notified body.

FIND CPR-COMPLIANT CABLES FOR ANY APPLICATION

All RFS CPR-compliant cables are also designated as low-smoke, zero-halogen (LSZH) and meet International Electrotechnical Commission (IEC) standards for flame spread, smoke acidity and low smoke emission. They are compatible with existing RFS connectors, factory-assembled jumpers, grounding kits and clamps, as well as trimming and preparation tools.

European class code labeling example

This table explains the CPR class codes using the rating for our CELLFLEX cables as an example: B2ca s1 d0 a1.

B2	ca	s1	d1	a1
Fire performance class	Application to cable	Smoke ratio	Droplets rating	Acidity rating
				
s1		d0	-	a1
s2		d1		a2
s3		d2		a3

CPR-COMPLIANT CABLES FOR IN-TUNNEL APPLICATIONS

A BROAD PORTFOLIO OF CPR-COMPLIANT CABLES

Since July 1, 2017, all communications cables installed in buildings in the European Union (EU) must meet the fire performance requirements in European standard EN 50575 and include the CE marking to comply with EU Construction Products Regulation (CPR) No. 305/2011.

RFS was the first cable vendor to offer RF communications cables with the highest CPR classifications for fire safety. Today, we offer a wide range of CELLFLEX® coaxial cables and RADIAFLEX® radiating cables that comply with European CPR No. 305/2017. This directive requires that coax and radiating cables meet the fire performance standards in the EN 50575 standard and be classified according to the EN 13501-6 standard.

RFS cables are classified according to the CPR test standards and criteria listed below.

		CPR CLASSIFICATION			
		B2ca: +++	Cca: ++	Dca: +	Eca: -
Test Standard and Measurement					
IEC 60332-1-2	Flame spread	≤ 425 mm	≤ 425 mm	≤ 425 mm	≤ 425 mm
EN 50399	Flame spread	≤ 4.5 m	≤ 2.0 m	-	-
EN 50399	Total heat release	≤ 15 MJ	≤ 30 MJ	≤ 70 MJ	-
EN 50399	Peak heat release	≤ 30 kW	≤ 40 kW	≤ 400 kW	-
EN 50399	Fire grow rate	≤ 150 Ws-1	≤ 3000 Ws-1	≤ 1300 Ws-1	-
ADDITIONAL CLASSIFICATIONS					
EN 50399	Smoke emission	s1, s2, s3	s1, s2, s3	s1, s2, s3	-
EN 61034	Smoke density	s1a, s1b	s1a, s1b	s1a, s1b	-
EN 50399	Burning droplets	d0, d1, d2	d0, d1, d2	d0, d1, d2	-
EN 6754-2	Corrosivity	a1, a2, a3	a1, a2, a3	a1, a2, a3	-

The CPR burning droplets classification is particularly important because burning particles can ignite other cables or infrastructure. Only class d0 cables create no burning particles to deliver the highest levels of fire protection in buildings and tunnels.



SAFETY IS KEY

FIRE SAFETY STANDARDS & REGULATIONS

RADIAFLEX Radiating Cables

CABLE	JACKET OPTION		
	JFNA	JFLA	CPR
RADIAFLEX RLK types 1/2"	Cca s1a d1 a1	Cca s1a d0 a1	B2ca s1a d0 a1
RADIAFLEX RLK, RLF, RAY types 7/8"	Dca s1b d2 a1	Dca s1b d2 a1	B2ca s1a d0 a1
RADIAFLEX RLK, RLF, RAY types 1-1/4"	Dca s1 d2 a1	Dca s1 d2 a1	B2ca s1b d0 a1
RADIAFLEX RLK, RLF, RAY types 1-5/8"	Dca s2 d2 a1	Cca s1b d1 a1	B2ca s1a d0 a1
RADIAFLEX RCF types 1/2"	Cca s1a d1 a1	Not available	Not available
RADIAFLEX RSF types 1/2"	Cca s1a d1 a1	Not available	Not available

CELLFLEX Flame-Retardant Cables

SIZE	CABLE	CHARACTERISTIC	FIRE CLASS
1/4"	SCF14-50 JFN	Superflexible	B2ca s1a d0 a1
1/4"	LCF14-50 JFN	Low Loss	B2ca s1a d1 a1
1/2"	SCF12-50 JFN	Superflexible	B2ca s1a d0 a1
1/2"	LCF12-50 JFN	Low Loss	B2ca s1 d0 a1
7/8"	LCF78-50 JFNA	Low Loss	B2ca s1a d0 a1
1-1/4"	LCFS114-50 JFNA	Low Loss	B2ca s1b d2 a1
1-1/4"	LCFS114-50 CPR	Low Loss	B2ca s1b d0 a1
1-5/8"	LCF158-50 JFNA	Low Loss	Cca s1a d2 a1
1-5/8"	LCF158-50 CPR	Low Loss	Cca s1a d0 a1

Please check the last status of Declaration of Performance (DoP) on [rfsworld.com](https://www.rfsworld.com): <https://www.rfsworld.com/searchengine/cpr>

FLAME AND FIRE-RETARDANT JACKETS				
STANDARD (International, European & National)		JACKET OPTION		
		CPR	JFN ¹	JFL ¹
IEC 60754-1/-2	Halogen free, non-corrosive	✓	✓	✓
IEC 60332-1 EN 50265-2-1 DIN VDE 0482 Teil 265-2-1	Flame test	✓	✓	✓
IEC 60332-3-24 (Category C) EN 50266-2-4 DIN VDE 0482 Teil 266-2-4	Cable bundle test	✓	✓ ²	✓
IEC 61034 EN 50268-2 DIN VDE 0482 Teil 268-2	Low smoke emission	✓	✓ ³	✓



1. This includes additional design/tuning options indicated with an additional letter, e.g. new A-series of Radiaflex cables: JA, JFNA, JFLA
2. Not for RCF and RSF type
3. RFS RADIAFLEX® radiating cables with jacket option JFN are low smoke and exhibit excellent flame and fire retardant performance. To characterize the low smoke behavior of RFS cables under fire conditions, RFS applies the test method as described in IEC 61034 low smoke emission. Considering the application of radiating cables (not installed in bundles) the test is done with one sample for all cable sizes.

CABLES AND CONNECTORS FOR EVERY TUNNEL AND INDOOR APPLICATION

In addition to RADIAFLEX®, RFS offers CELLFLEX® coaxial cables. They are designed to meet in-building and in-tunnel communications requirements today and tomorrow. Our high-quality connectors maintain signal integrity end-to-end.

CELLFLEX® LOW-LOSS CABLES

CELLFLEX cables make up the largest corrugated transmission-line portfolio in the wireless infrastructure industry. The foam dielectric cables combine remarkable flexibility with high strength and superior electrical performance to ensure uninterrupted communications. This premium transmission line family is backed by a complete line of accessories, including the renowned OMNI FIT™ connector range.

Twenty unique CELLFLEX types, ranging in size from 1/4" to 1-5/8", provide users with a perfect match for even the most complicated and demanding applications. Every cable comes with a guarantee of reliability, performance and cost-effectiveness.

OMNI FIT™ CONNECTOR FAMILIES

RFS connectors are designed for high performance, easy installation and full compatibility throughout the CELLFLEX family. The entire range of innovative OMNI FIT™ Premium and OMNI FIT™ Standard connectors work with all CELLFLEX® cables. A perfect complement to the CELLFLEX® transmission line range, OMNI FIT™ connectors provide users with familiar connection options, premium electrical characteristics and reliable, long-life use.

RFS' OMNI FIT™ Standard connectors are designed to meet and exceed industry standard Voltage Standing Wave Ratio (VSWR) and PIM performance. The connectors offer a cost-effective, high-quality connector-to-cable interface for easy, fast and safe connector attachment.

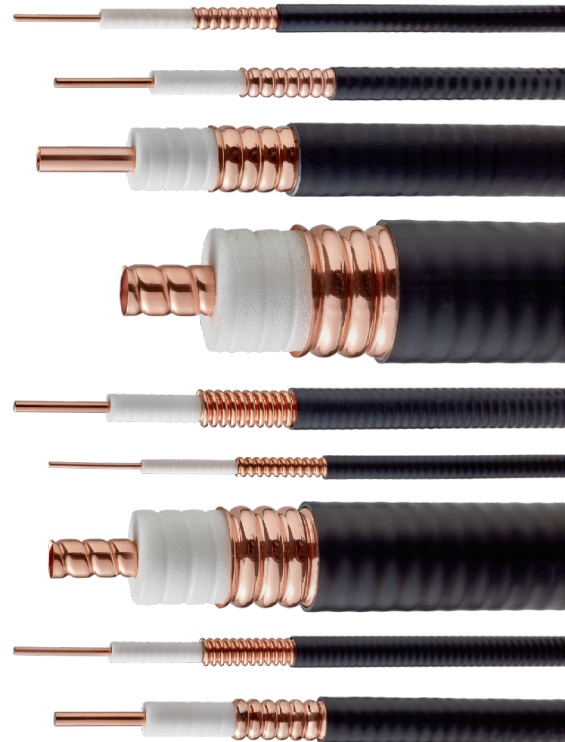

COMPLETE SHIELDING

The solid outer conductor on CELLFLEX coaxial cables creates a continuous RFI/EMI shield that minimizes system interference.

LOW VSWR

Special low voltage standing wave ratio (VSWR) CELLFLEX variants help maintain system integrity.

OUTSTANDING INTERMODULATION PERFORMANCE

The solid inner and outer conductors virtually eliminate intermodulation.

HIGH POWER RATING

Low attenuation, excellent heat transfer properties and temperature stabilized dielectric material ensure safe, long-term operation at high transmit power levels.

WIDE RANGE OF APPLICATIONS

CELLFLEX cables support frequency bands up to 6000 MHz to enable a wide range of in-building applications.



INSTALL RADIAFLEX WITH CONFIDENCE

RADIAFLEX INSTALLATION ASPECTS AND ACCESSORIES

Positioning the cables

RADIAFLEX® cables are available with bulges or guides. In order to achieve the best performance, the guides and the bulges should be installed in a defined position.

In order to achieve the best performance of radiating waveguides the slots should be installed in direction of coverage. The slots are marked by the printing on the jacket.

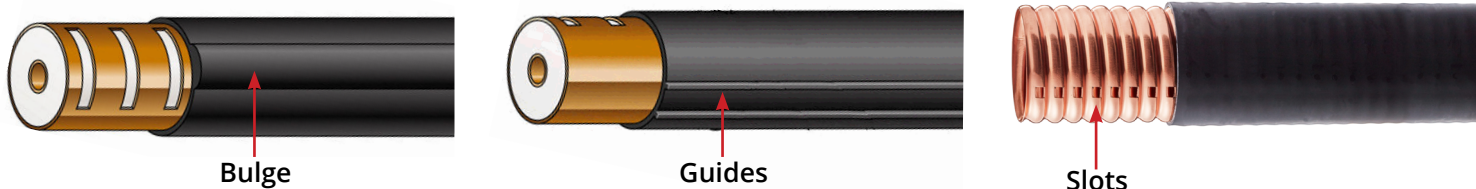

SMART FIXING SOLUTION (SFS) CLAMP SERIES

The Smart Fixing Solution (SFS) clamp family ensures a safe and reliable RADIAFLEX cable installation in harsh environmental tunnel conditions. The SFS clamps also allow for an optimized installation process minimizing customer's total cost of ownership (TCO) – an aspect that is essentially important as installation time in tunnel environment is a key factor in deployments affecting overall solution cost.

SAFE & RELIABLE INSTALLATIONS WHERE CRITICAL COMMUNICATION IS ESSENTIAL

The SFS clamps are based on a one-piece, self-closing plastic pipe clamp for the fixing of radiating cables in road, railway and metro tunnels. The SFS clamps also allow for more flexibility regarding compatibility regarding installation hardware such as e.g. screws, dowels and, consequently, allow for easier adaptation to customer specific installation need.

The SFS clamps in combination with RFS worldwide leading RADIAFLEX radiating cable portfolio have also been optimized to avoid any passive intermodulation (PIM) effects which is particularly important in highly reflective in tunnel environments to avoid network interferences and ensure highest possible network throughput.

The clamps also feature a fire secured mounting functionality by allowing additional metal cable ties to be installed together with the SFS clamps.

SFS Clamps offer:

- Simple and quick assembly
- Closing system without additional screws
- Secure closure, no opening
- Fixed wall distance 80 mm
- Integrated fire protection device
- Anchor and screw fastening available with standard products; Bolt setting technology is also available



INSTALL RADIAFLEX WITH CONFIDENCE

SFS Clamp Types

MODEL NUMBER	USE
SFS-12-01	for 1/2" cables (except RSF12)
SFS-78-01	for 7/8" cables
SFS-114-01	for 1-1/4" cables
SFS-158-01	for 1-5/8" cables

Fixation Options

MODEL NUMBER	DESCRIPTION
SFS-PLUG-6-01	Plastic Dowel
SFS-SC650-02	Screw for Plastic Dowel
SFS-FIX-644-02	Metal Plug with Head
SFS-FIX-649-02	Metal Plug with Nut

Tools

MODEL NUMBER	DESCRIPTION
TOOL-SFS-FIX-01	Setting tool for SFS Metal Plug with head / nut
TOOL-SFS-FIX-D	Drilling tool for SFS Metal Plug with head / nut

BEST PRACTICES DURING THE INSTALLATION PROCESS

Care should be taken to ensure that the hole is always drilled at right angles to the surface of the wall so that the clamps do not become twisted during the subsequent assembly. The hole should be cleaned out with an air pump after drilling. Three different fixing options are available. Make sure the clamps are lined up; otherwise, the cable will not run in a perfectly straight line. After installing the cable, the clips are closed by simply pressing the closure into position.

This insert (metallic tie) for SFS clamp types was developed for situations which require the cable to remain functional for as long as possible in the event of a fire. The cable should not become detached from the wall or ceiling in order to prevent an escape route from being blocked.

In case of fire, the resistant part of the fixing will hold the cable in position and enables the cable to keep in operation as long as the cable itself allows. The recommended installation spacing for these clamps is approximately every 8-10 m.

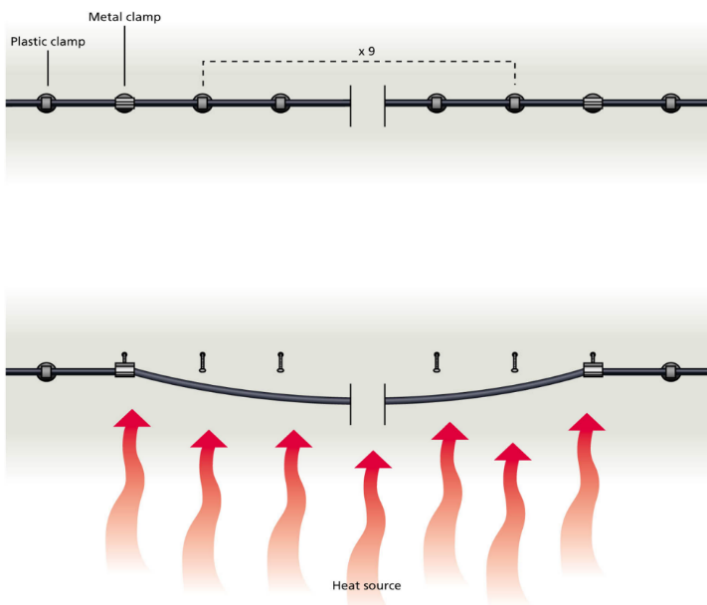

INSTALL RADIAFLEX WITH CONFIDENCE

PREVENT PIM INTERFERENCE TO MAINTAIN OVERALL SYSTEM PERFORMANCE

Radiating cables are distributed antennas and, consequently, metal obstacles in close proximity to the cable – notably to the radiating slots – may impact radiation behavior and might cause passive intermodulation (PIM) effects. This is especially true in scenarios where a metal dowel and the metal tie wrapped around the cable might make contact. PIM effects might significantly degrade overall system performance and KPI's for wireless communication systems. In order to avoid metallic contact between the fire secured tie and the metal dowel, a plastic insert has been provided to ensure the highest possible robustness against PIM interferences.

Fire Protection Inserts

MODEL NUMBER	USE	SIZE
SFS-12-F	for SFS-12-01 clamp (1/2")	L = 247 mm (9.72 in)
SFS-78-F	for SFS-78-01 clamp (7/8")	L = 300 mm (11.81 in)
SFS-114-F	for SFS-114-01 clamp (1-1/4")	L = 330 mm (12.99 in)
SFS-158-F	for SFS-158-01 clamp (1-5/8")	L = 335 mm (13.18 in)

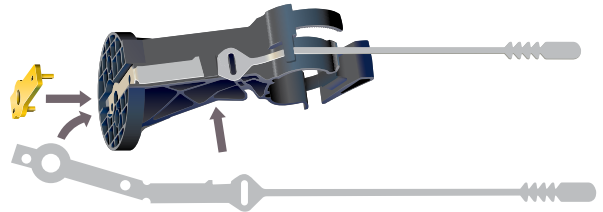

CLIC CLAMP INSTALLATION

RLK, RAY and RLV type RADIAFLEX cables require a round base with a height H = 80 mm. These clamps are fixed with a plastic plug Ø 6 mm and a stainless steel screw.

Care should be taken to ensure that the hole is always drilled at right angles to the surface of the wall so that the clamps do not become twisted during the subsequent assembly. The hole should be cleaned out with an air pump after drilling. The clamp is fixed by means of a round head wood-screw tightened with a TORX bit screw driver (T 25) or with a cordless electric screwdriver and corresponding TORX bit.

Make sure the clamps are lined up; otherwise the cable will not run in a perfectly straight line. The minimum bending radii for installing cables should also be taken into account when fixing the clamps. When attaching the cable, the action of pressing the cable into the clamp with the hand causes the clamp to close automatically.

Please refer to the datasheet of the individual cable to review the recommended clamp spacing.

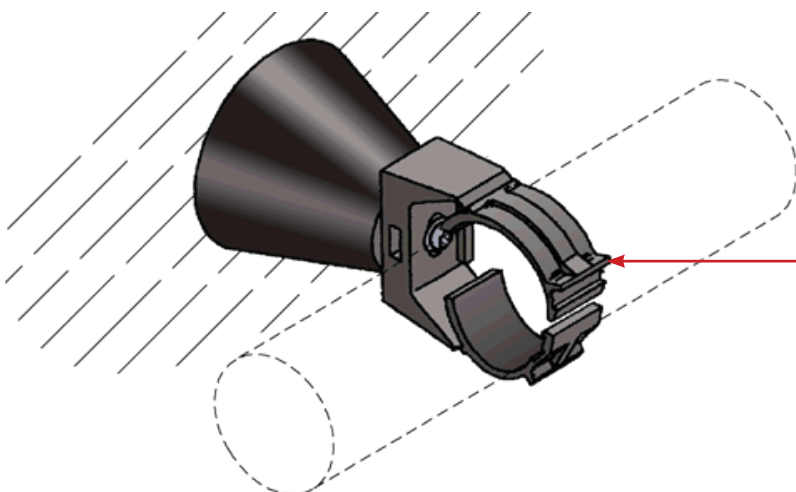

POSITION

Pay attention to the bulge or guides on the cable jacket

CLIC-CLAMP

Mount the cables by simply pushing the cable in by hand. The clamp will grip and lock by applying light pressure

INSTALL RADIAFLEX WITH CONFIDENCE

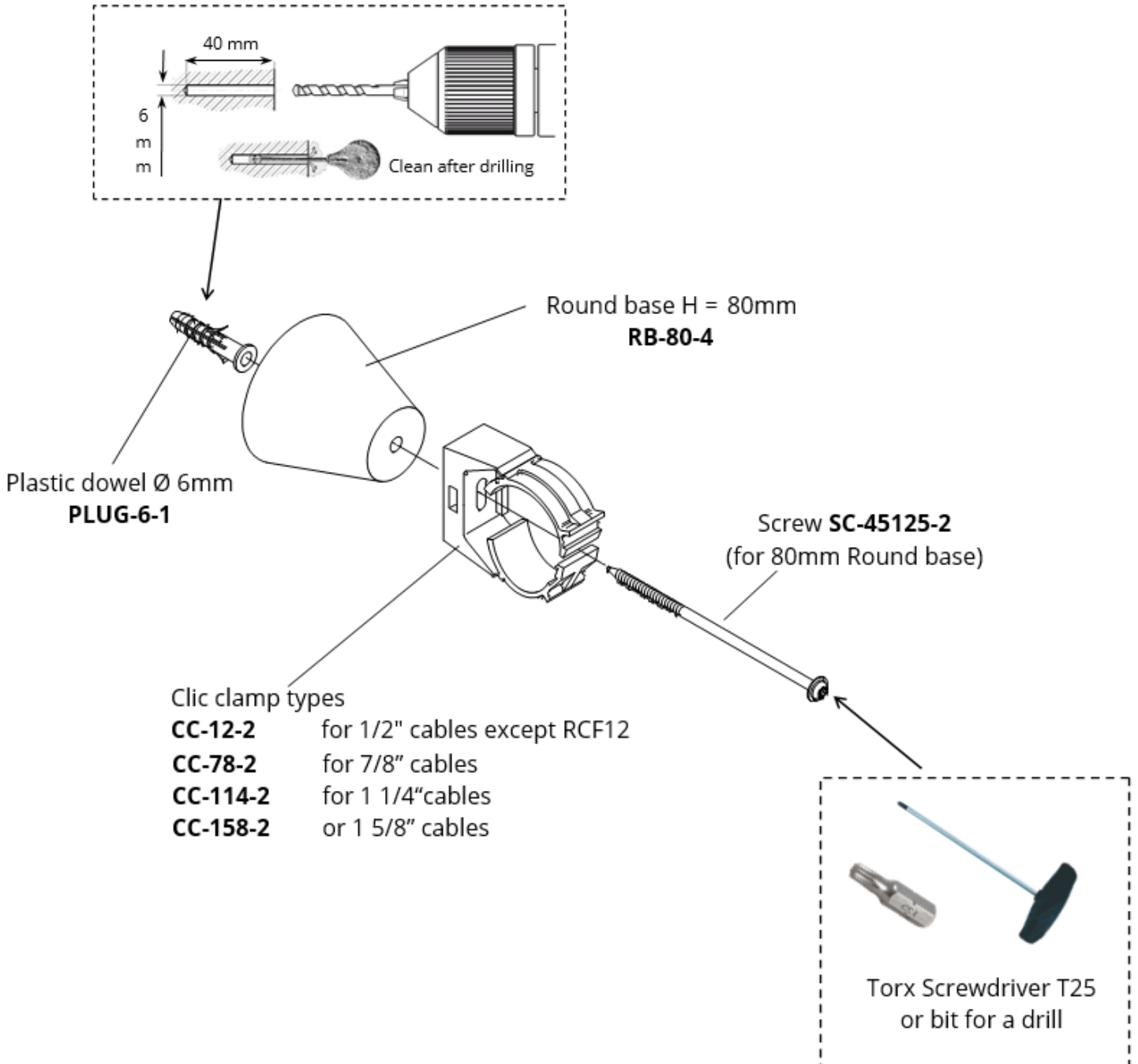

INSTALL RADIAFLEX WITH CONFIDENCE

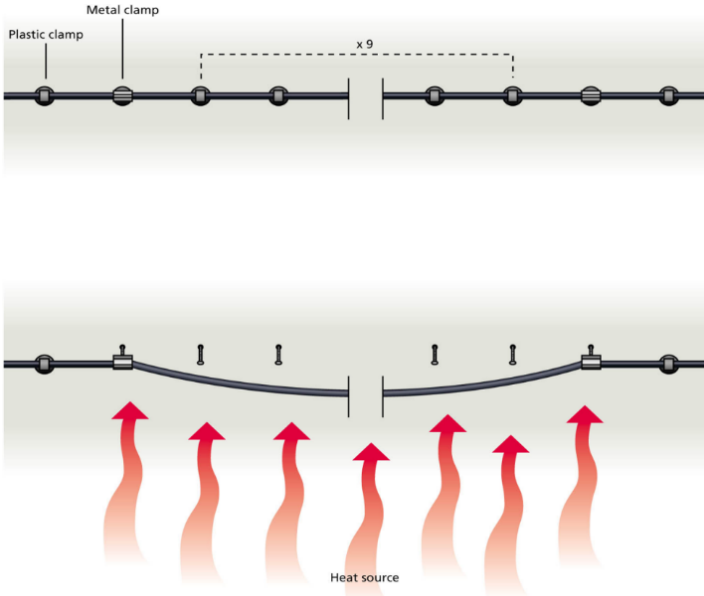

SAFETY IS KEY

In case of fire, the resistant part of the fixing will hold the cable in position and enables the cable to keep in operation as long as the cable itself allows. It also prevents the cable from detaching from the wall which could block escape routes.

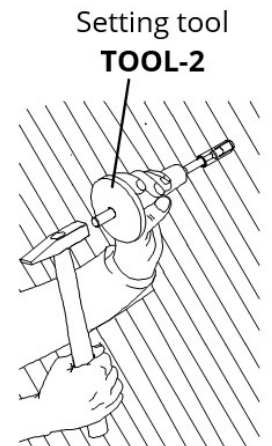
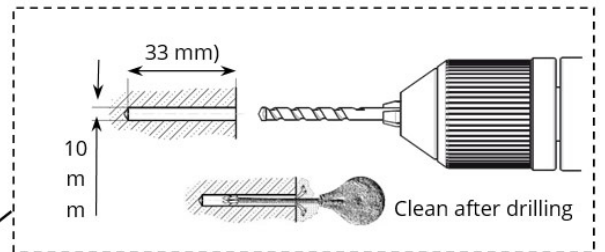
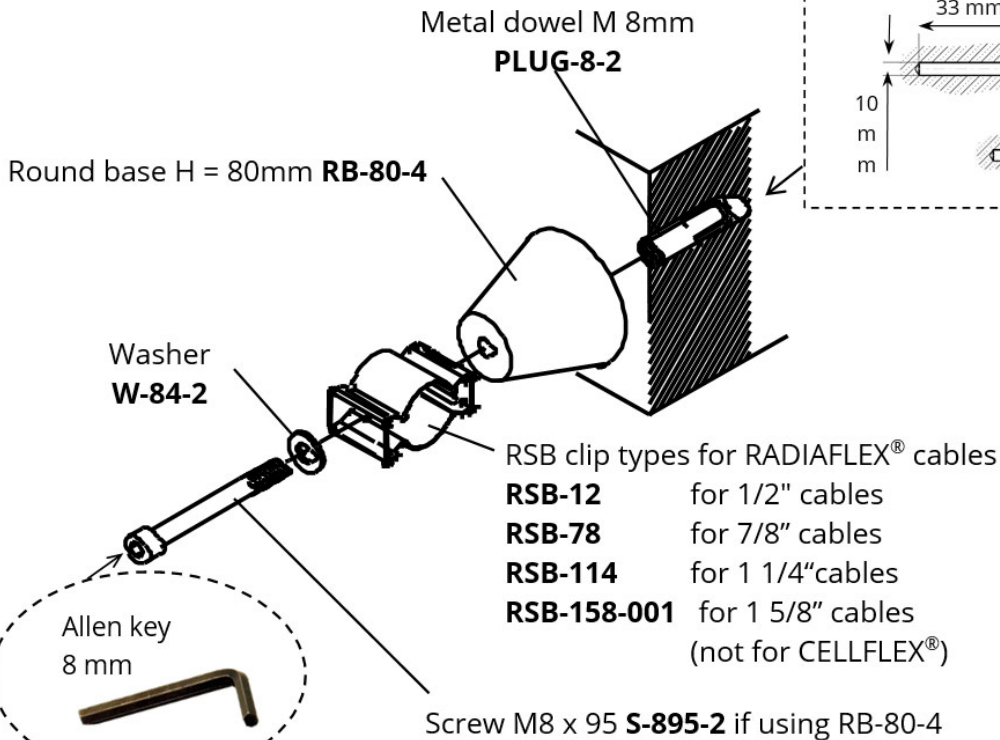

RADIAFLEX OVERVIEW

RADIATING CABLE BASICS

RFS RADIAFLEX cables support all services up to 6 GHz with high performance, making them ideal for multiband, multi-operator applications in the most challenging indoor and underground environments.

HOW THEY WORK

- Coaxial cable designed and constructed to radiate and receive RF energy over its entire length.
- Designed to replace traditional antennas
- Ensure line of sight everywhere between radio system and antenna
- Combined with other indoor solutions products to enhance RF coverage

Frequency Range

The design of the apertures in the outer conductor influences the frequency for which the cable is optimized. RADIAFLEX® cables are usually classified into categories: for operation up to 960 MHz, 1900 MHz and 2700 MHz (6000 MHz). Cables optimized for special frequency ranges are available on request

Longitudinal Loss

This is a measure of signal loss in the cable over its entire length

Coupling Loss

This is a measure of the signal loss between the cable and a test receiver at a distance of 2m (6.5ft)

System Loss

This is the sum of longitudinal loss and coupling loss

Reception probability

50% - where 50 percent of all measured samples are better than stated performance figures

95% - where 95 percent of all measured samples are better than stated performance figures

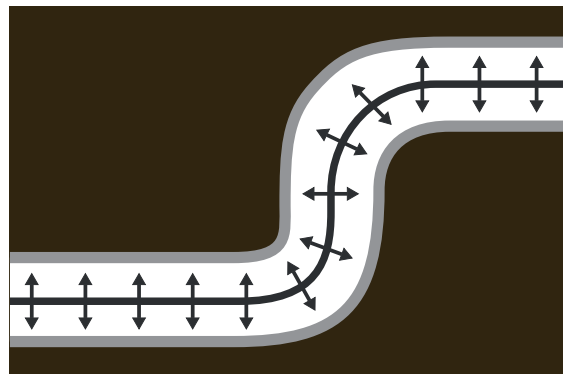

NORMAL RF CABLE



RADIATING CABLE

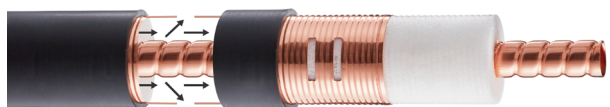

Transmitting (downlink)

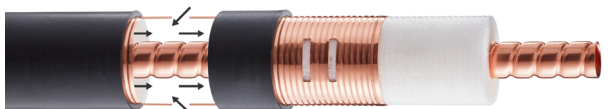

Receiving (uplink)

HOW IS THIS DONE

By cutting holes or slots in the outer conductor of coaxial cables, enabling RF power to enter or leave the cable.

RADIAFLEX OVERVIEW

RADIATING CABLE BASICS

LONGITUDINAL LOSS a_l SIGNAL LOSS IN CABLE

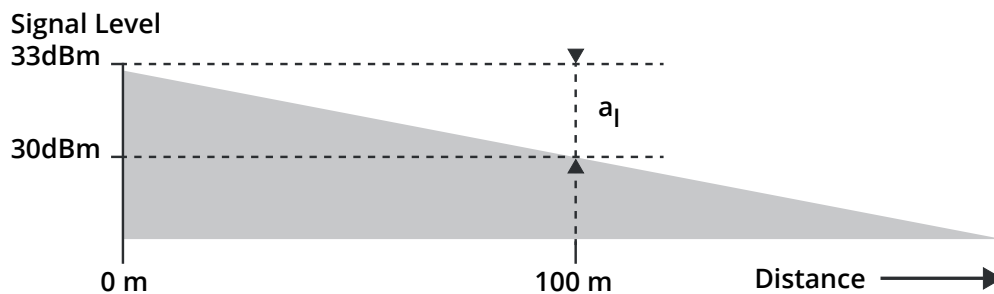
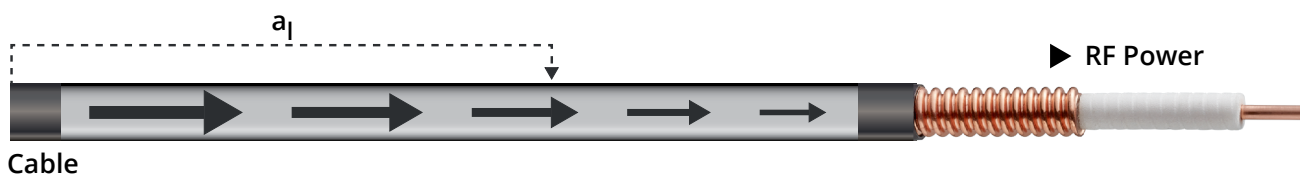

Example: $a_l = 3 \text{ dB} / 100 \text{ m}$
Note: a_l increases with frequency!

COUPLING LOSS a_c SIGNAL LOSS BETWEEN CABLE AND MOBILE DEVICE

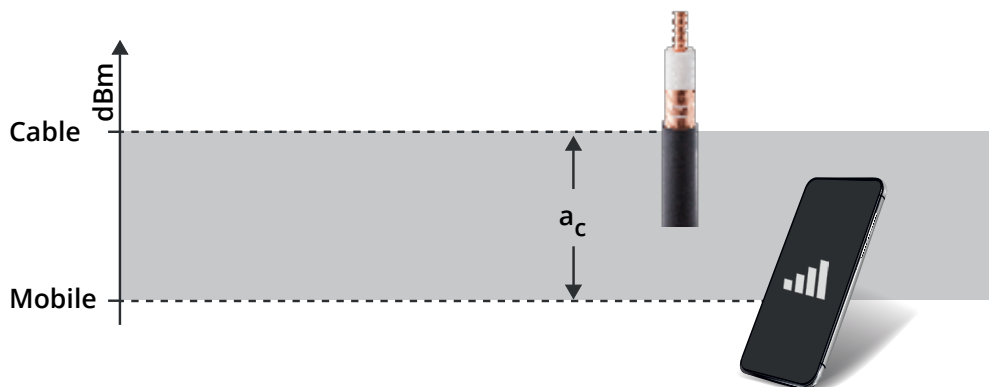

RADIAFLEX OVERVIEW

RADIATING CABLE BASICS

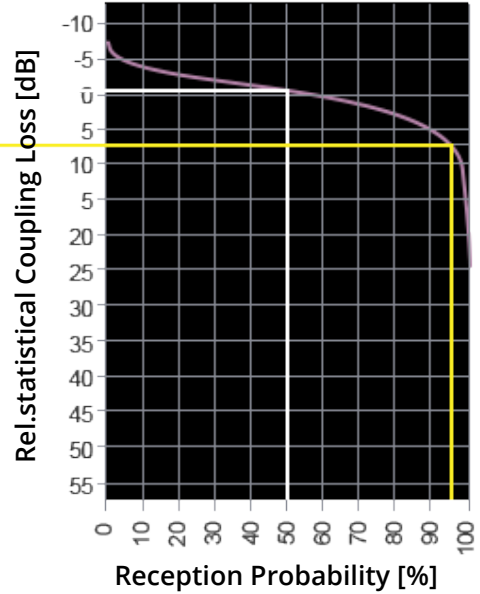
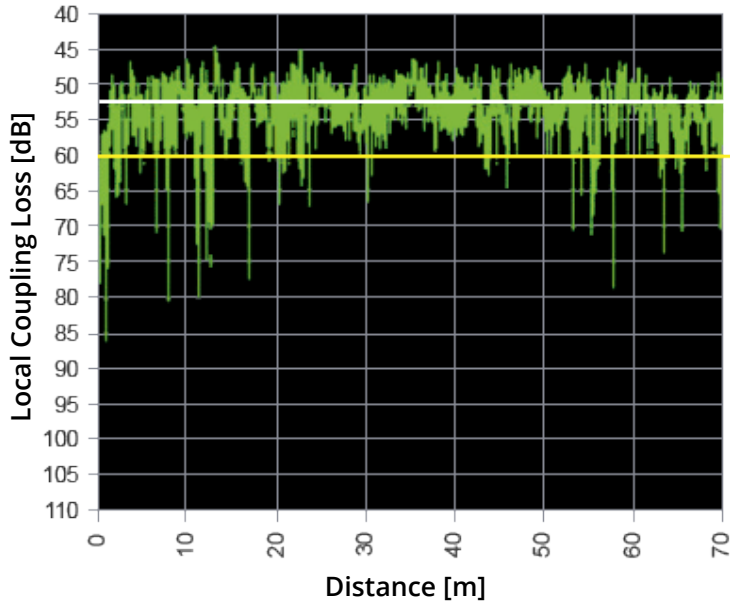

ACCORDING TO IEC 61 196-4

Standard measurement along a cable run of approx. 100 m length

MEASUREMENT CONDITIONS

- Free space
- No environmental influences
- No tunnel effects

COUPLING LOSS MEASURED BY

- Height above ground: 2 m
- Distance between cable and antenna: 2 m
- Type of antenna: $\lambda/2$ dipole
- Spatial orientation of dipole antenna: radial, orthogonal or parallel

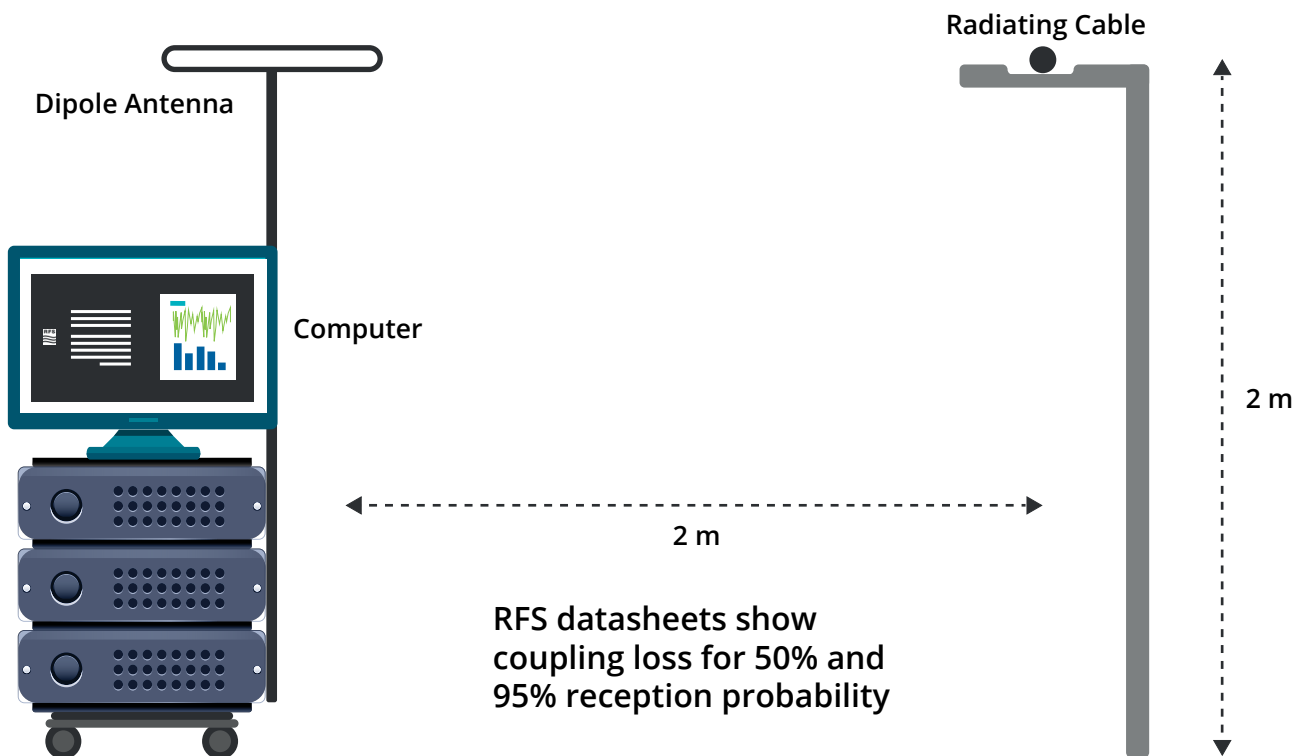



RADIO FREQUENCY SYSTEMS



TO SERVE YOU BETTER
Any questions comments or suggestions that would help us improve our products and services? **Scan this QR code!**